

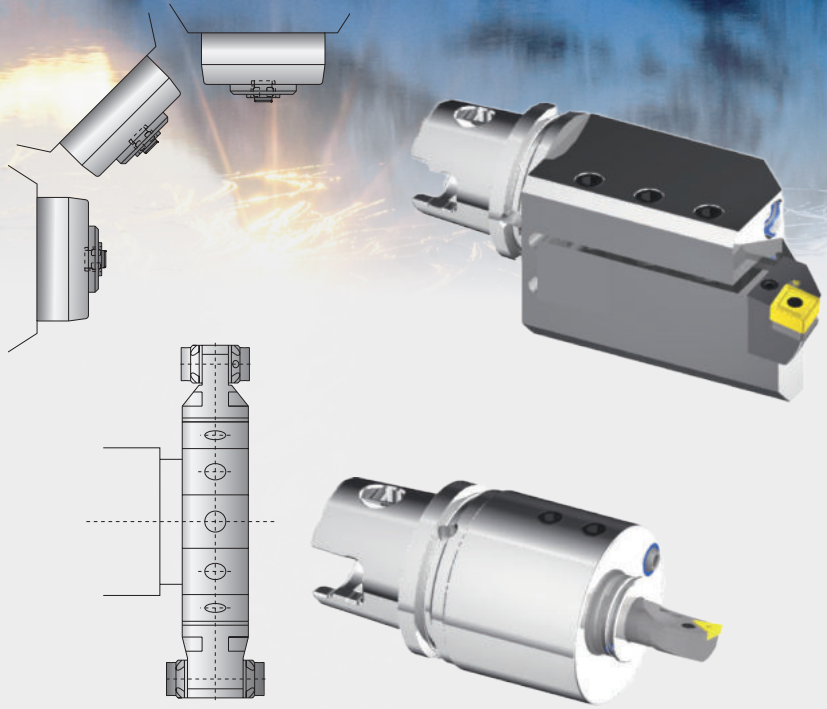

SWISS  TOOLS<sup>®</sup>



*S w i s s*  
**KM XMZ**

*KM Toolholders  
Turning, Milling and  
Boring Solutions*

## Schrumpffutter

- Standardausführung für hohe Klemmkraft
- für HM- und HSS-Werkzeuge
- Schafttoleranz h6
- Rundlaufgenauigkeit 3 µm
- Aufnahmen feingewuchtet G 2.5/15000 U/min
- axiale Längenverstellung

## Heat shrink chuck

- standard design for a better clamping force
- for solid carbide and high speed steel tools
- shank tolerance h6
- true running 3 µm
- fine balanced toolholders G 2.5/15000 r/min
- axial adjustment



Bestell-Nr. / Order number	d	D	D1	L	L1	L2	L min	L max
KY6.S04.K01.080*	4	10	17	80	62		12	
KY6.S06.K01.080	6	21	27	80	62	38	36	22
KY6.S06.K01.120	6	21	27	120	102	38	36	22
KY6.S08.K01.080	8	21	27	80	62	38	36	26
KY6.S08.K01.120	8	21	27	120	102	38	36	26
KY6.S10.K01.080	10	24	32	80	62	51	41	31
KY6.S10.K01.120	10	24	32	120	102	51	41	31
KY6.S12.K01.080	12	24	32	80	62	51	46	36
KY6.S12.K01.120	12	24	32	120	102	51	46	36
KY6.S14.K01.080	14	27	34	80	62	44	46	36
KY6.S14.K01.120	14	27	34	120	102	44	46	36
KY6.S16.K01.080	16	27	34	80	62	44	49	39
KY6.S16.K01.120	16	27	34	120	102	44	49	39
KY6.S18.K01.080	18	33	41	80	62	51	49	39
KY6.S18.K01.120	18	33	41	120	102	51	49	39
KY6.S20.K01.080	20	33	41	80	62	51	51	41
KY6.S20.K01.120	20	33	41	120	102	51	51	41
KY6.S25.K01.080	25	44	53	80	62	57	57	47
KY6.S25.K01.120	25	44	53	120	102	57	57	47
KY6.S32.K01.080	32	44	53	80	62	57	61	51
KY6.S32.K01.120	32	44	53	120	102	57	61	51

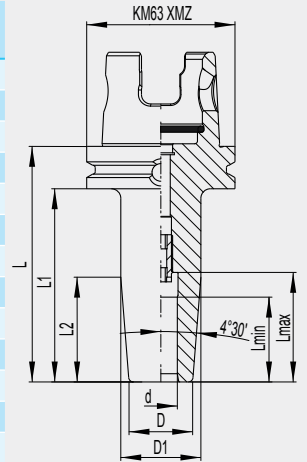

## Ersatzteile / Zubehör

## Spare parts / Accessories

Für Schrumpffutter /  
For heat shrink chuck

Bestell-Nr. /  
Order number

Dimension

Anschlagschraube /  
Stop screw

①

xxx.S06.xxx.xxx	ERU.AN1.K01.014	M 5 x 14
xxx.S08.xxx.xxx	ERU.AN2.K01.016	M 6 x 16
xxx.S10.xxx.xxx	ERU.AN3.K01.020	M 8 x 1 x 16
xxx.S12 . . . S14.xxx.xxx	ERU.AN4.K01.020	M10 x 1 x 20
xxx.S16 . . . S20.xxx.xxx	ERU.AN5.K01.020	M12 x 1 x 20
xxx.S25 . . . S50.xxx.xxx	ERU.AN5.K01.020	M12 x 1 x 20

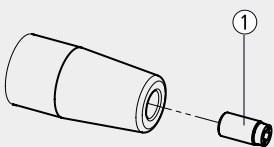

### Fräseraufnahmen Whistle Notch

### End mill adapter Whistle Notch

- zur Aufnahme von Werkzeugen mit Zylinderschaft nach DIN 6359

- to clamp tools with cylindrical shank according to DIN 6359

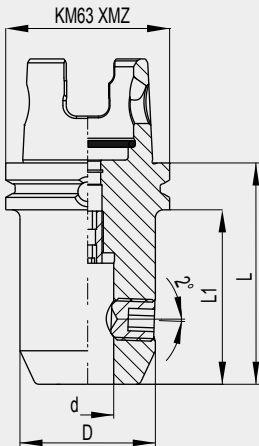

Bestell-Nr. / Order number	d	D	L	L1
KY6.N06.K01.060	6	25	60	42
KY6.N08.K01.065	8	28	65	47
KY6.N10.K01.070	10	35	70	52
KY6.N12.K01.075	12	42	75	57
KY6.N14.K01.075	14	45	75	57
KY6.N16.K01.080	16	48	80	62
KY6.N18.K01.080	18	48	80	62
KY6.N20.K01.080	20	52	80	62
KY6.N25.K01.085	25	63	85	67
KY6.N32.K01.095	32	72	95	77



### Flächenspannfutter Weldon

### End mill adapter Weldon

- zur Aufnahme von Werkzeugen mit Zylinderschaft nach DIN 1835 B

- to clamp tools with cylindrical shank according to DIN 1835 B

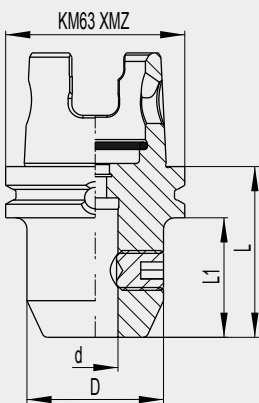

Bestell-Nr. / Order number	d	D	L	L1
KY6.W06.K01.060	6	25	60	42
KY6.W06.K01.100	6	25	100	82
KY6.W08.K01.060	8	28	60	42
KY6.W08.K01.100	8	28	100	82
KY6.W10.K01.060	10	35	60	42
KY6.W10.K01.100	10	35	100	82
KY6.W12.K01.060	12	42	60	42
KY6.W12.K01.100	12	42	100	82
KY6.W14.K01.060	14	45	60	42
KY6.W14.K01.100	14	45	100	82
KY6.W16.K01.060	16	48	60	42
KY6.W16.K01.100	16	48	100	82
KY6.W18.K01.060	18	48	60	42
KY6.W18.K01.100	18	48	100	82
KY6.W20.K01.065	20	52	65	47
KY6.W20.K01.100	20	52	100	82
KY6.W25.K01.080	25	65	80	62
KY6.W32.K01.090	32	72	90	72



### Ersatzteile / Zubehör

### Spare parts / Accessories

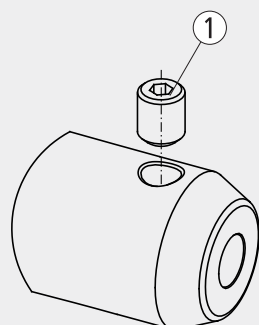

Für Fräsespannfutter For end mill adapter	Bestell-Nr. / Order number	Dimension
	<b>Klemmscharube / Clamping screw</b> ①	
xxx.x06.xxx.xxx	W06.ER1.001.010	M 6 x 10
xxx.x08.xxx.xxx	W08.ER1.001.010	M 8 x 10
xxx.x10.xxx.xxx	W10.ER1.001.012	M10 x 12
xxx.x12 . . . x14.xxx.xxx	W12.ER1.001.016	M12 x 16
xxx.x16 . . . x18.xxx.xxx	W16.ER1.001.016	M14 x 16
xxx.x20.xxx.xxx	W20.ER1.001.016	M16 x 16
xxx.x25.xxx.xxx	W25.ER1.001.020	M18 x 2 x 20
xxx.x32.xxx.xxx	W32.ER1.001.020	M20 x 2 x 20

### Spannzangenfutter ER

- für Spannzangen nach DIN 6499
- zur Aufnahme von Werkzeugen mit Zylinderschaft
- axiale Längenverstellung



Bestell-Nr. / Order number	Range	D	D1	L	L1
KY6.E16.K01.060	0.5-10	28	28	60	42
KY6.E16.K01.120	0.5-10	28	28	120	102
KY6.E20.K01.060	0.5-13	34	34	60	42
KY6.E20.K01.120	0.5-13	34	34	120	102
KY6.E25.K01.060	0.5-16	42	42	60	42
KY6.E25.K01.120	0.5-16	42	42	120	102
KY6.E32.K01.060	1-20	50	50	60	42
KY6.E32.K01.090	1-20	50	50	90	72
KY6.E32.K01.120	1-20	50	50	120	102
KY6.E40.K01.090	2-30	63	50	90	72
KY6.E40.K01.120	2-30	63	50	120	102

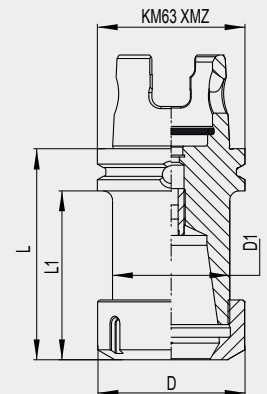

### Spannzangenfutter ER-MINI

- für Spannzangen nach DIN 6499
- zur Aufnahme von Werkzeugen mit Zylinderschaft
- axiale Längenverstellung



Bestell-Nr. / Order number	Range	D	D1	L	L1
KY6.E11.K01.060	0.5-7	16	16	60	42
KY6.E11.K01.090	0.5-7	16	16	90	72
KY6.E17.K01.060	0.5-10	22	22	60	42
KY6.E17.K01.100	0.5-10	22	22	100	82
KY6.E17.K01.120	0.5-10	22	22	120	102

### Collet chuck ER-MINI

- for collets according to DIN 6499
- to clamp tools with cylindrical shank
- axial adjustment

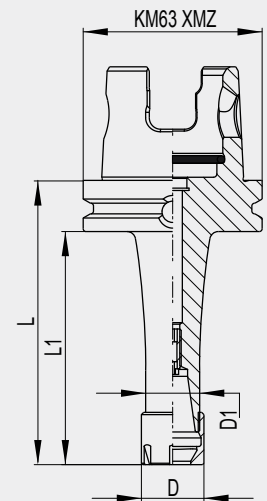

### Ersatzteile / Zubehör

### Spare parts / Accessories

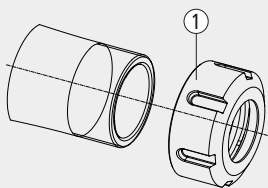

Für Spannzangenfutter

Bestell-Nr. /  
Order number

Dimension

For collet chuck

Spannmutter /  
Clamping nut

①

xxx.E11.xxx.xxx	E11.ER1.001.012	M13 x 0.75
xxx.E16.xxx.xxx	E16.ER1.001.018	M22 x 1.5
xxx.E17.xxx.xxx	E17.ER1.001.018	M19 x 1
xxx.E20.xxx.xxx	E20.ER1.001.019	M25 x 1.5
xxx.E25.xxx.xxx	E25.ER1.001.020	M32 x 1.5
xxx.E32.xxx.xxx	E32.ER1.001.023	M40 x 1.5
xxx.E40.xxx.xxx	E40.ER1.001.025	M50 x 1.5

## Fräsdorn

## Milling arbor

- zur Aufnahme von Fräsern mit Längs- und Quernut
- eingeschraubte Mitnehmerbolzen
- to clamp milling cutters with longitudinal and cross drive
- screwed drive bolt

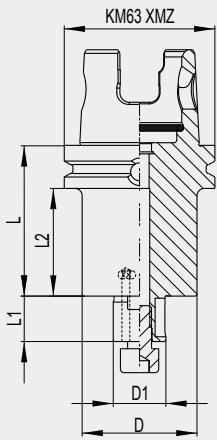

Bestell-Nr. / Order number	D1	D	L	L1	L2
KY6.D16.K21.028	16	38	28	17	10
KY6.D16.K21.063	16	38	63	17	45
KY6.D16.K21.110	16	38	110	17	92
KY6.D22.K21.030	22	48	30	19	12
KY6.D22.K21.063	22	48	63	19	45
KY6.D22.K21.110	22	48	110	19	92
KY6.D27.K21.032	27	58	32	21	14
KY6.D27.K21.063	27	58	63	21	45
KY6.D27.K21.110	27	58	110	21	92
KY6.D32.K21.040	32	72	40	24	22
KY6.D32.K21.063	32	72	63	24	45
KY6.D32.K21.110	32	72	110	24	92

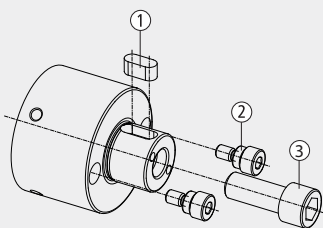

Für Fräsdorn For milling arbors	Bestell-Nr. / Order number	Bestell-Nr. / Order number	Bestell-Nr. / Order number	Dimension
	Passfeder / Fitting key ①	Mitnehmerbolzen / Drive bolt ②	Fräseranzugschraube / Clamping screw ③	
xxx.D16.xxx.xxx	D16.ER3.001.014	D16.ER2.001.015	D16.ER1.002.025	M 8 x 25
xxx.D22.xxx.xxx	D22.ER3.001.014	D22.ER2.001.017	D22.ER1.002.025	M10 x 25
xxx.D27.xxx.xxx	D27.ER3.001.018	D27.ER2.001.021	D27.ER1.002.030	M12 x 30
xxx.D32.xxx.xxx	D32.ER3.001.020	D32.ER2.001.022	D32.ER1.002.035	M16 x 35
xxx.D40.xxx.xxx	D40.ER3.001.022	D40.ER2.001.023	D40.ER1.002.040	M20 x 40



Werkzeughalter axial

Tool holder axial



Bestell-Nr. / Order number	B	C	D	L	L1	L2	R/L
KY6.V20.L11.100	20	20	80	100	75	55	L
KY6.V20.R11.100	20	20	80	100	75	55	R
KY6.V25.L11.130	25	25	102	130	105	85	L
KY6.V25.R11.130	25	25	102	130	105	85	R

Left-hand shown

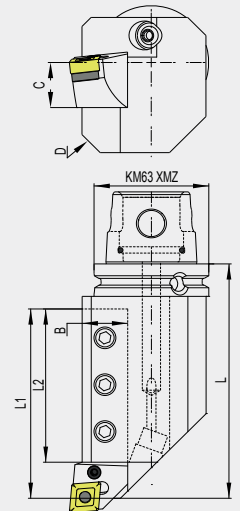

Werkzeughalter axial doppelt

Tool holder axial double



Bestell-Nr. / Order number	B	C	D	E	L	L2	L3	R/L
KY6.V20.L22.085	20	71	80	10	85	60	18	L
KY6.V20.R22.085	20	71	80	10	85	60	18	R
KY6.V25.L22.085	25	87	100	13	85	60	18	L
KY6.V25.R22.085	25	87	100	13	85	60	18	R

Left-hand shown

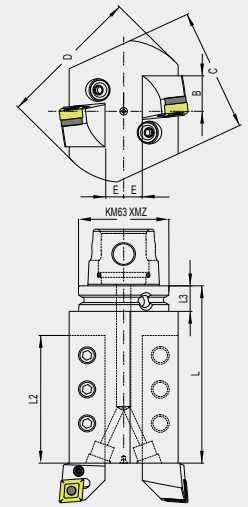

Werkzeughalter axial dreifach

Tool holder axial triple



Bestell-Nr. / Order number	C	D	E	L	L2	L3	R/L
KY6.V25.L31.125	25	115	23	125	80	18	L
KY6.V25.R31.125	25	115	23	125	80	18	R

Left-hand shown

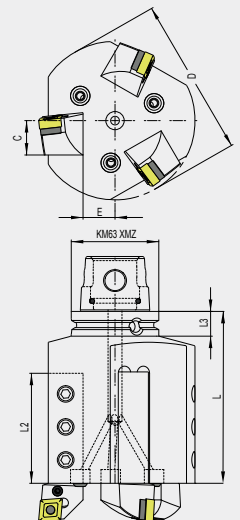

Werkzeughalter diagonal 45°

Tool holder diagonal 45°

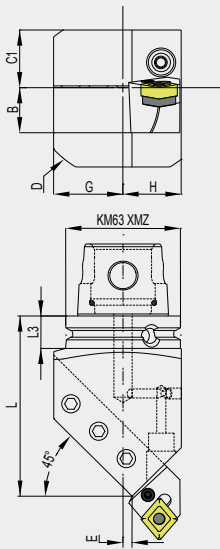

Bestell-Nr. / Order number	B	C1	D	E	G	H	L	L3	R/L
KY6.V20.L12.085	20	32	80	5	30	32	85	18	L
KY6.V20.R12.085	20	32	80	5	30	32	85	18	R
KY6.V25.L12.100	25	32	102	5	38	32	100	18	L
KY6.V25.R12.100	25	32	102	5	38	32	100	18	R

Left-hand shown



Werkzeughalter radial

Tool holder radial

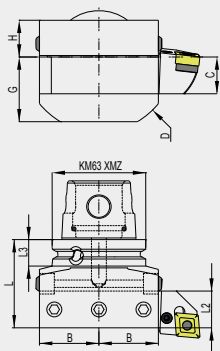

Bestell-Nr. / Order number	B	C	D	G	H	L	L2	L3
KY6.V20.N11.060	30	20	80	35	25	60	20	18
KY6.V25.N11.060	40	25	102	44	25	60	25	18



Bohrstangenhalter Typ ADI

Boring bar holder type ADI

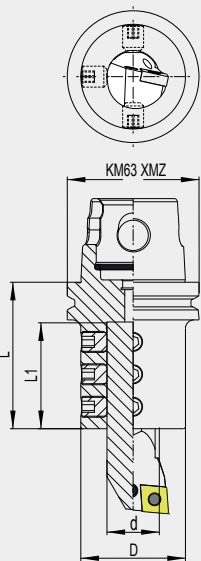

Bestell-Nr. / Order number	d	D	L	L1
KY6.B06.K01.060	6	34	60	36
KY6.B08.K01.060	8	34	60	36
KY6.B10.K01.060	10	34	60	36
KY6.B12.K01.060	12	36	60	36
KY6.B16.K01.065	16	40	65	51
KY6.B20.K01.070	20	44	70	51
KY6.B25.K01.070	25	50	70	51
KY6.B32.K01.080	32	56	80	66
KY6.B40.K01.105	40	63	105	-



Bohrstangenhalter Typ ABB

Boring bar holder type ABB

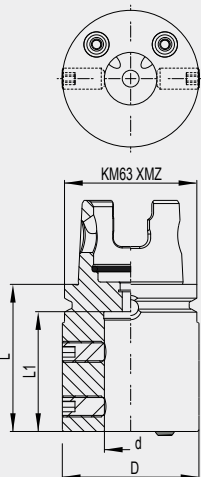

Bestell-Nr. / Order number	d	D	L	L1
KY6.B25.K20.070	25	65	70	57
KY6.B40.K20.105	40	80	105	66



Abstechhalter axial

Cut-off block axial

Bestell-Nr./ Order number	B	D	E	G	G1	H	L	L2	L3
KY6.AM3.K11.124 (R)	32	80	22	27.5	32	13	124	106	18
KY6.AM3.K12.124 (L)	32	80	22	27.5	32	13	124	106	18

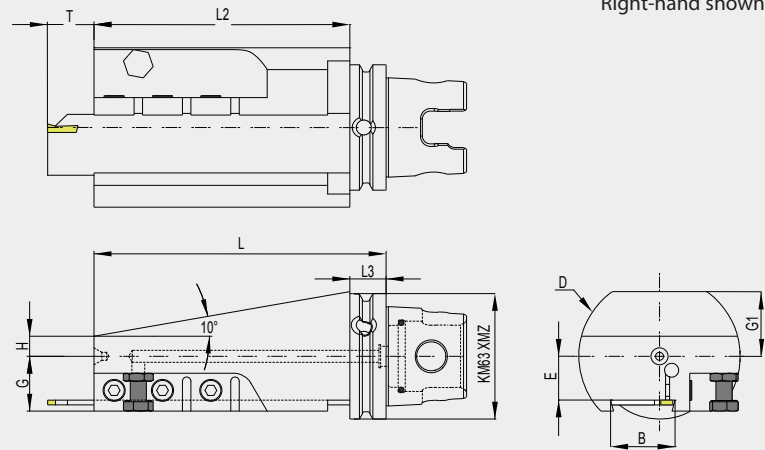

Ersatzteile / Zubehör

Spare parts / Accessories

Für Werkzeughalter/  
Für Bohrstangenhalter  
For tool holder/  
For boring bar holder

Bestell-Nr. /  
Order number

	Klemmschraube/ Clamping screw	Dimension
xxx.V20.xxx.xxx	ERU.GS6.001.018	M10 x 18
xxx.V25.xxx.xxx	ERU.GS7.001.025	M12 x 25
xxx.B06.xxx.xxx	ERU.GS4.001.010	M 6 x 10
xxx.B08...B12.xxx.xxx	ERU.GS5.001.010	M 8 x 10
xxx.B16...B40.xxx.xxx	ERU.GS6.001.012	M10 x 12